

USER GUIDE

FOR PICO NEO 3 SERIES



VIRTUAL REALITY ALL-IN-ONE HEADSET

IMPORTANT HEALTH & SAFETY NOTES

- This product is designed and intended to be used in an open and safe indoor area, free of any tripping or slipping hazards. To avoid accidents, remain conscious to the potential confines of your physical area and respect the boundary of your virtual area whenever you see it. Be sure to wear the lanyard when using the Controllers. Make sure that there is enough space around your head and body (at least 2 meters by 2 meters) to stretch your arms to avoid damage or injury to yourself, others, and your surroundings.
- This product is not recommended for users under 12 years of age. Children over 12 years old should only use this product under adult supervision.
- This product is designed to accommodate most prescription glasses. Take care to wear the VR Headset in a manner in which the VR Headset lenses do not rub or impact your prescription lenses.
- Prolonged use may cause dizziness or eye fatigue. It is recommended that you take a break every 30 minutes. You may be able to relieve eye strain by watching distant objects. If you feel any discomfort, please stop using the product immediately.
- Do not expose the optical lenses to direct sunlight or other strong light sources. Exposure to direct sunlight may cause permanent yellow spot damage on the screen. Screen damage caused by sunlight exposure or other strong sources of light is not covered by the warranty.
- To reduce the risk of discomfort, the inter-pupillary distance (IPD) should be appropriately set for each user.
- This product has an "Eye Protection Mode", certified by TUV Rheinland (Germany), which can protect your eyes by reducing blue light in the three color channels using software algorithms. The screen appears yellowish in this mode and you can turn this feature on/off in "Settings" → "Display" → "Eye Protection Mode".
- Protect optical lenses during use and storage to prevent damage.

*** Product and packaging are updated regularly, and the functions and contents of the standalone headset may be upgraded in the future. Therefore, the content, appearance and functionality listed in this manual and product packaging are subject to change and may not reflect the final product. These instructions are for reference only.**

6 DEGREES OF FREEDOM VR

The device can track your translational and rotational movements in all directions (up/down, left/right, forward/backward, pitch, roll, and yaw). Your movements in the real world will be captured and translated to what you see in the virtual world when using the appropriate content.

Ensure a safe environment before you start your VR experience.

1. Clear a safe indoor area of at least 2 meters by 2 meters. Keep the room bright, prevent to use the space with big and single color walls, glass, mirrors and moving pictures or objects.
2. Remove the protective film that covers the headset front cameras. Wear the lanyard connected to the Controllers.
3. Set up your environment by following instructions on the VR Head set screen.

Note: This product can not guarantee your safety with guardian system, you will need always pay attention to the surrounding safety.

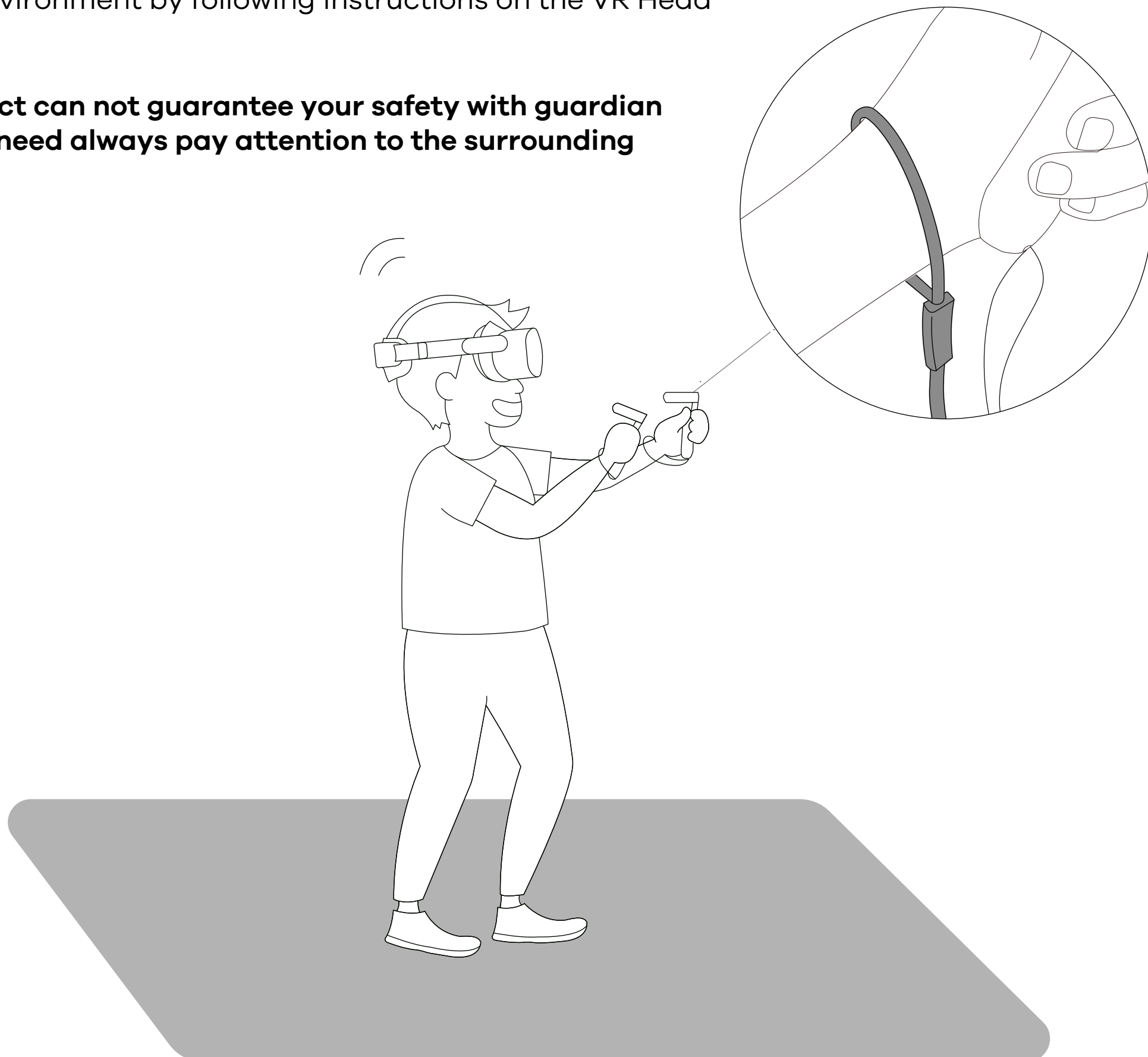

QUICK GUIDE

1

Installing Batteries

Press the area marked with an arrow and slide the cover down, then pull the tab to remove the insulating paper.

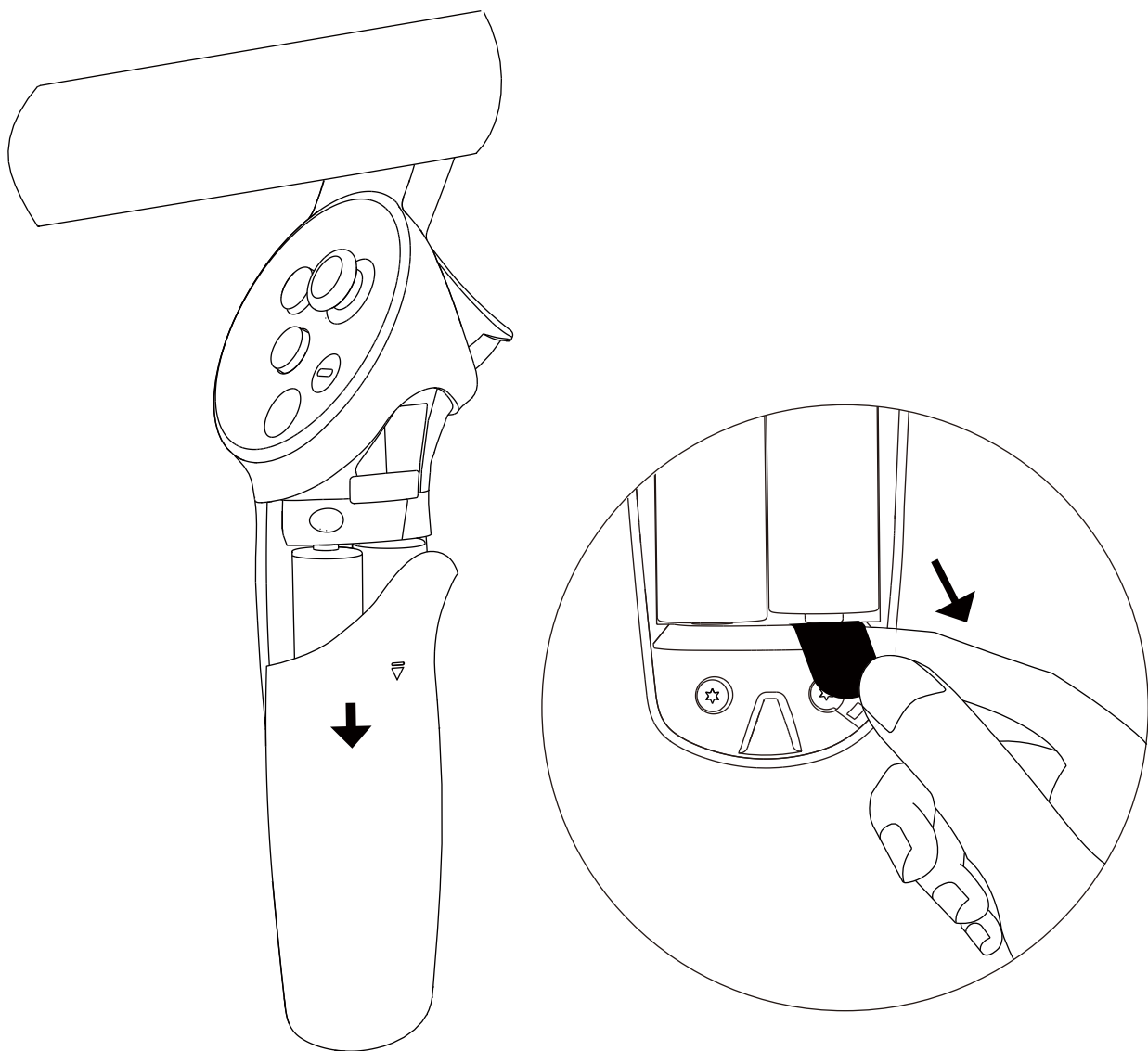
**2**

Power on the Controller

Short press the HOME button for 1 second until the status indicator flashes blue.

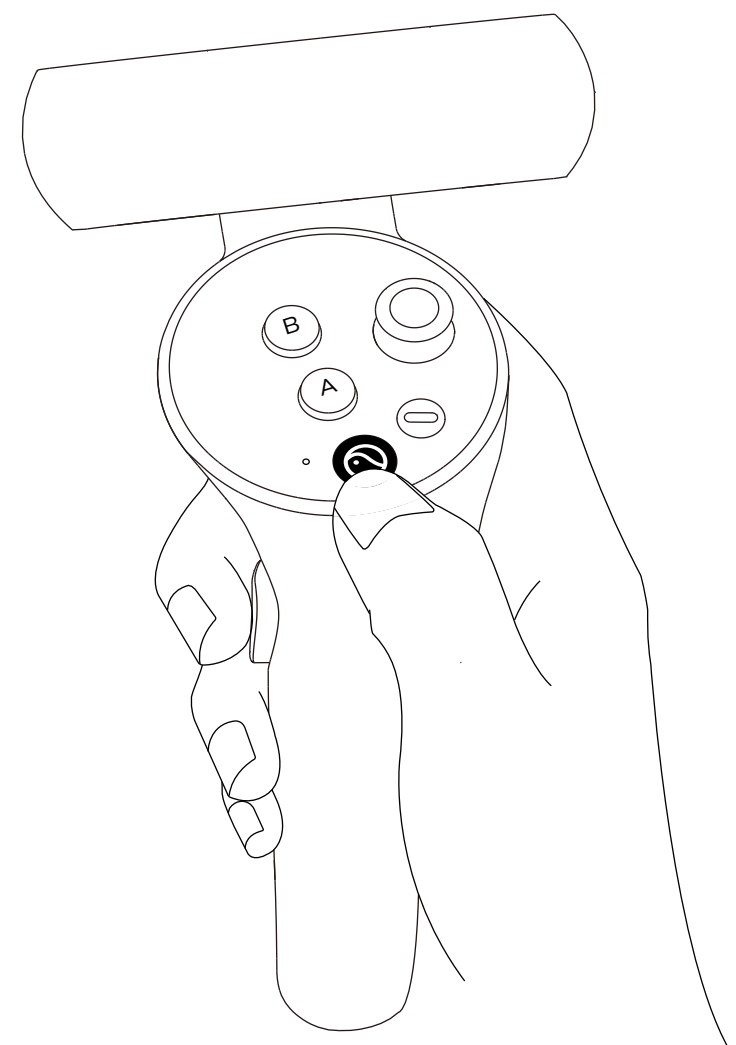

***Note: The 1.5V AA alkaline batteries are recommended to use.**

QUICK GUIDE

3

Power on the VR Headset

Long press the POWER button for 2 seconds until the status indicator turns blue.

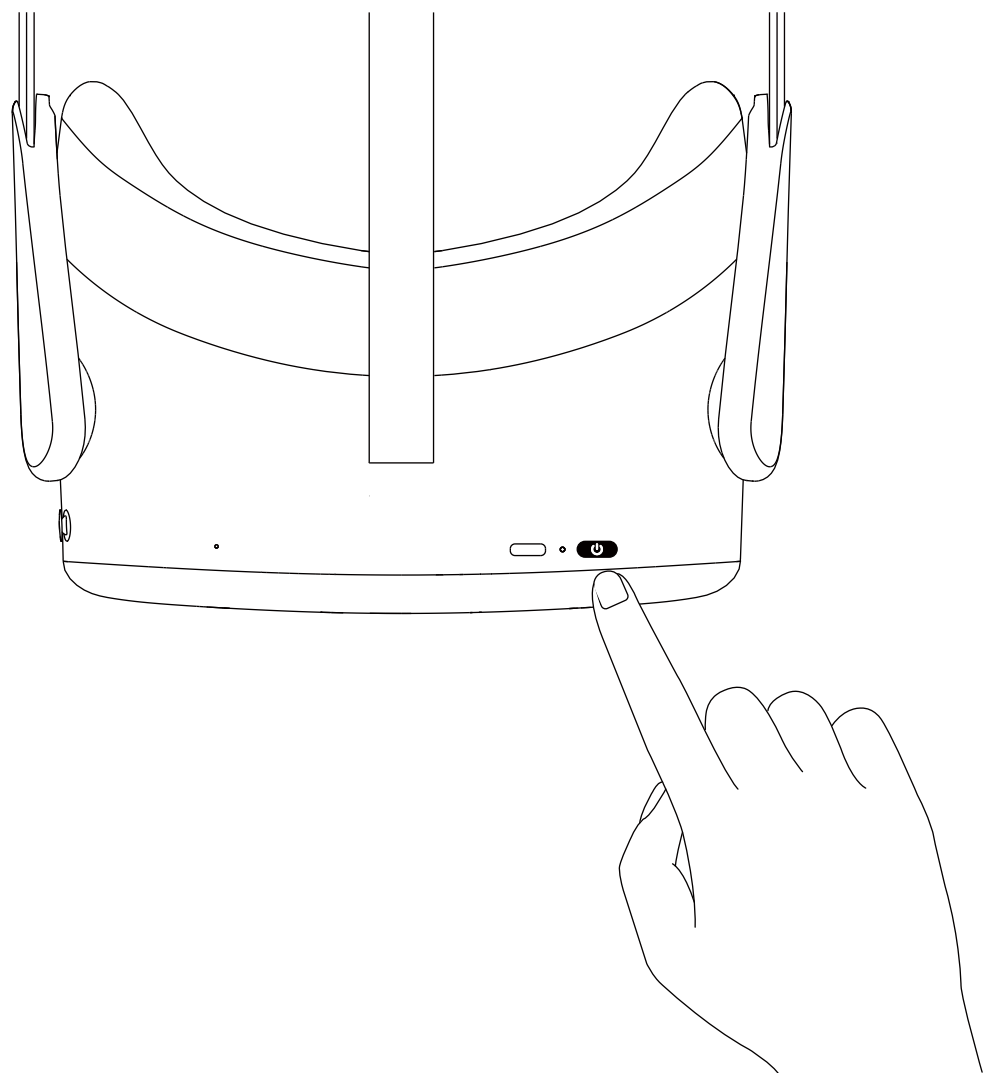
**5**

Adjust the Headband

Adjust side headband to comfortable and clear view position.

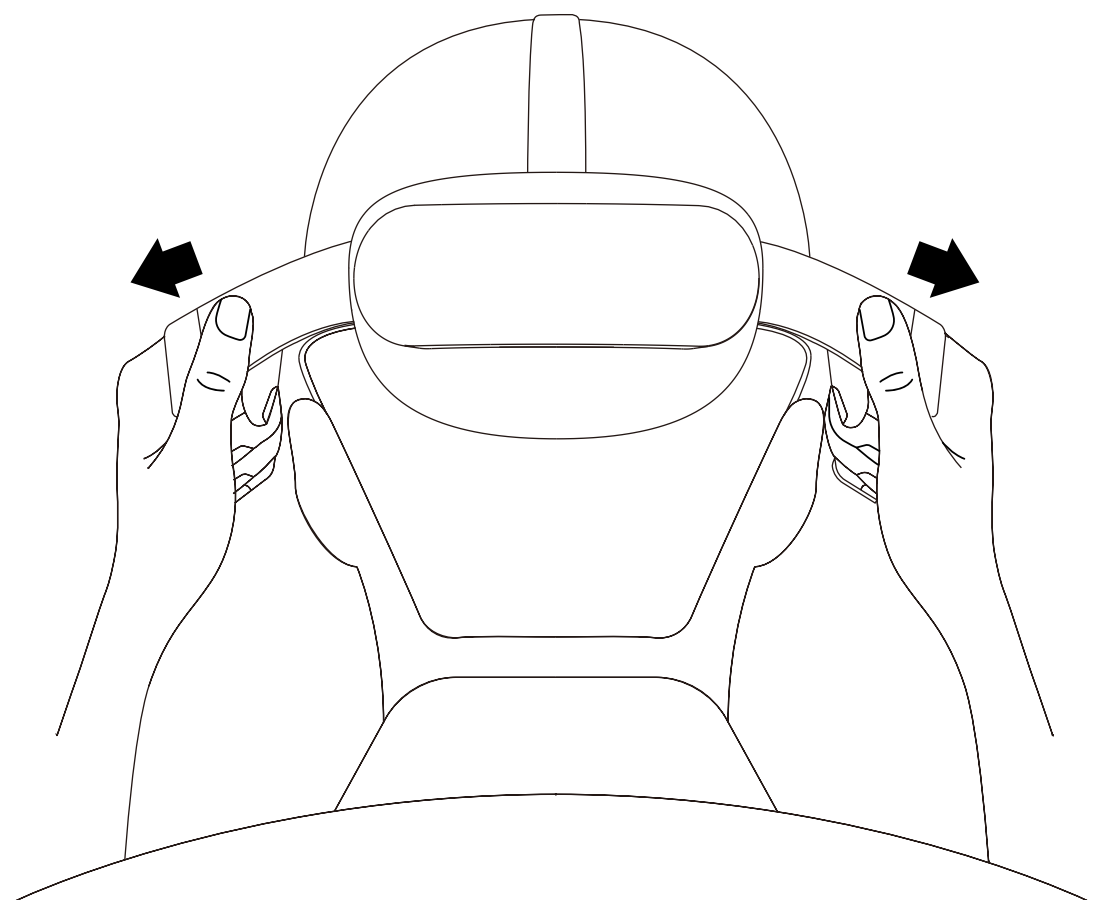
**4**

Wear the VR Headset

Rotate the strap down over your head.

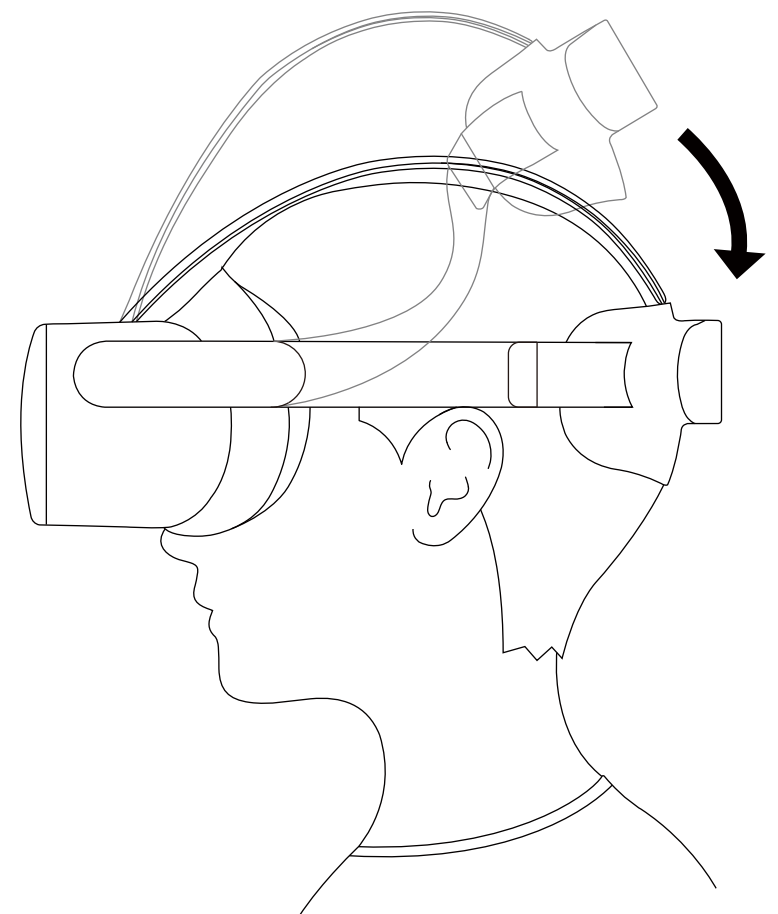

***Note: Nearsighted users can use this product with prescription glasses.**

PICO NEO 3 VR HEADSET DETAILS

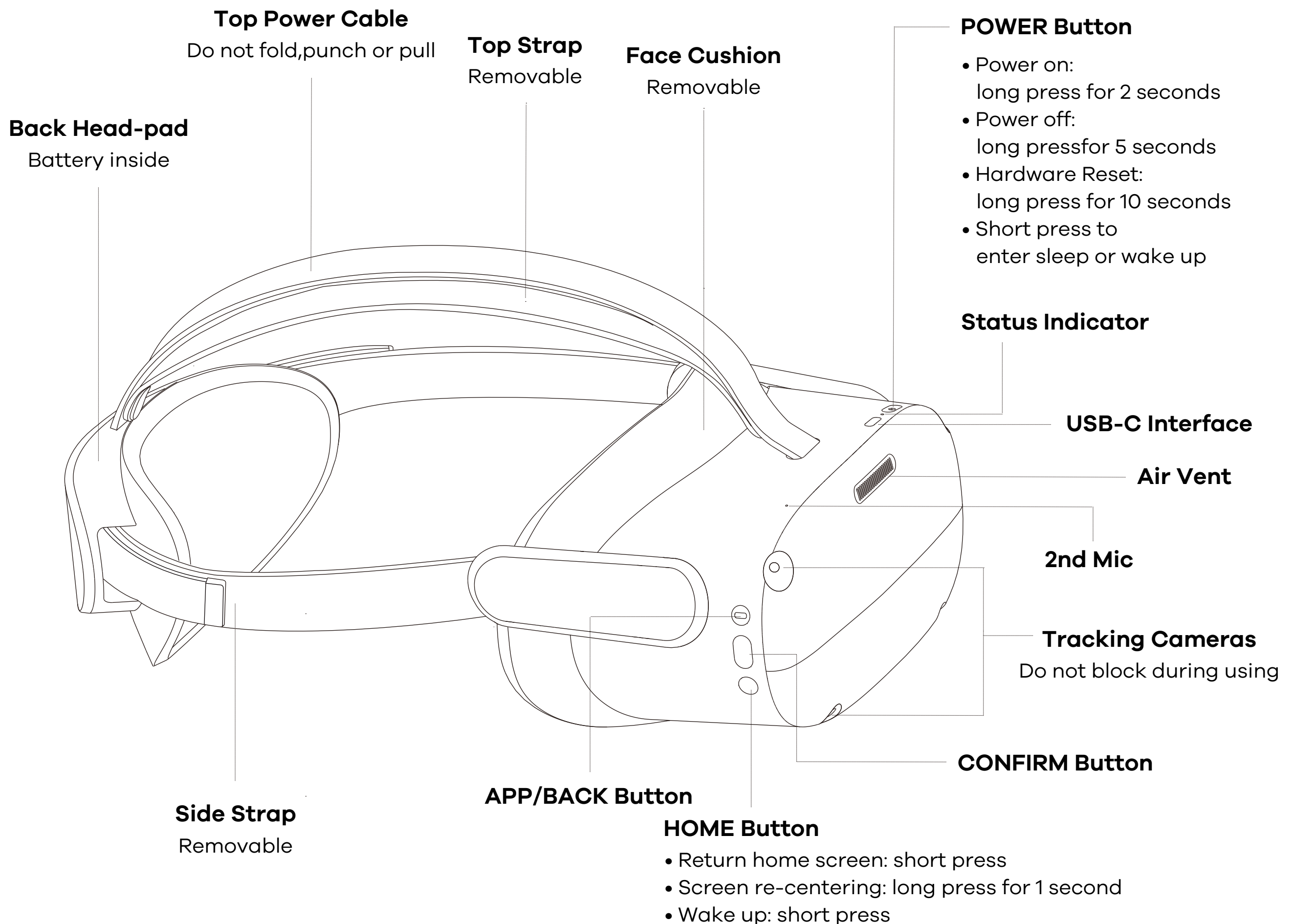

OPERATING INSTRUCTIONS

VR Headset Status Indicator Legend

- Blue: Powered on with battery over 20%
- Red: Charging: Battery is less than 20%
- Yellow: Charging: Battery is less than 98%
- Blue flashing: Shutting down
- Red flashing: Battery is less than 20%
- Off: Sleeping or Powered off
- Green: Charging: Battery is more than 98% or charge complete

Head Control Mode

If the Controller is not connected, you can interact with the home screen by moving your head to direct the crosshairs over your intended selection and clicking the HOME, CONFIRM, and BACK buttons on the VR Headset.

Screen re-centering

If you find the images have drifted off-center, look straight ahead, press and hold the HOME button of the Controller for more than 1 second to re-center the screen.

Audio volume adjustment

You can use the VOLUME button of the VR Headset to turn up or turn down the volume, and press it to continuously adjust the volume.

VR Headset reset

If the picture in the VR Headset is stuck, or the VR Headset does not respond after short-press the HOME button or the POWER button, you can press the Power button of VR Headset for more than 10 seconds to reboot the VR Headset.

Sleep/Wake up

Option 1 (Proximity Sensor):

Take off VR Headset for automatic sleeping : wear the VR Headset for automatic waking up

Option 2 (POWER Button)

Press the POWER button for manual sleeping or waking up.

OPERATING INSTRUCTIONS

IPD Adjustment

To ensure image clarity , it is necessary to line up the lenses with the distance between your pupils (IPD)

There are three lens spacing settings-58mm , 63 . 5mm , and 69mm . To adjust the IPD , gently move both lenses inward or outward to find the clearest setting.

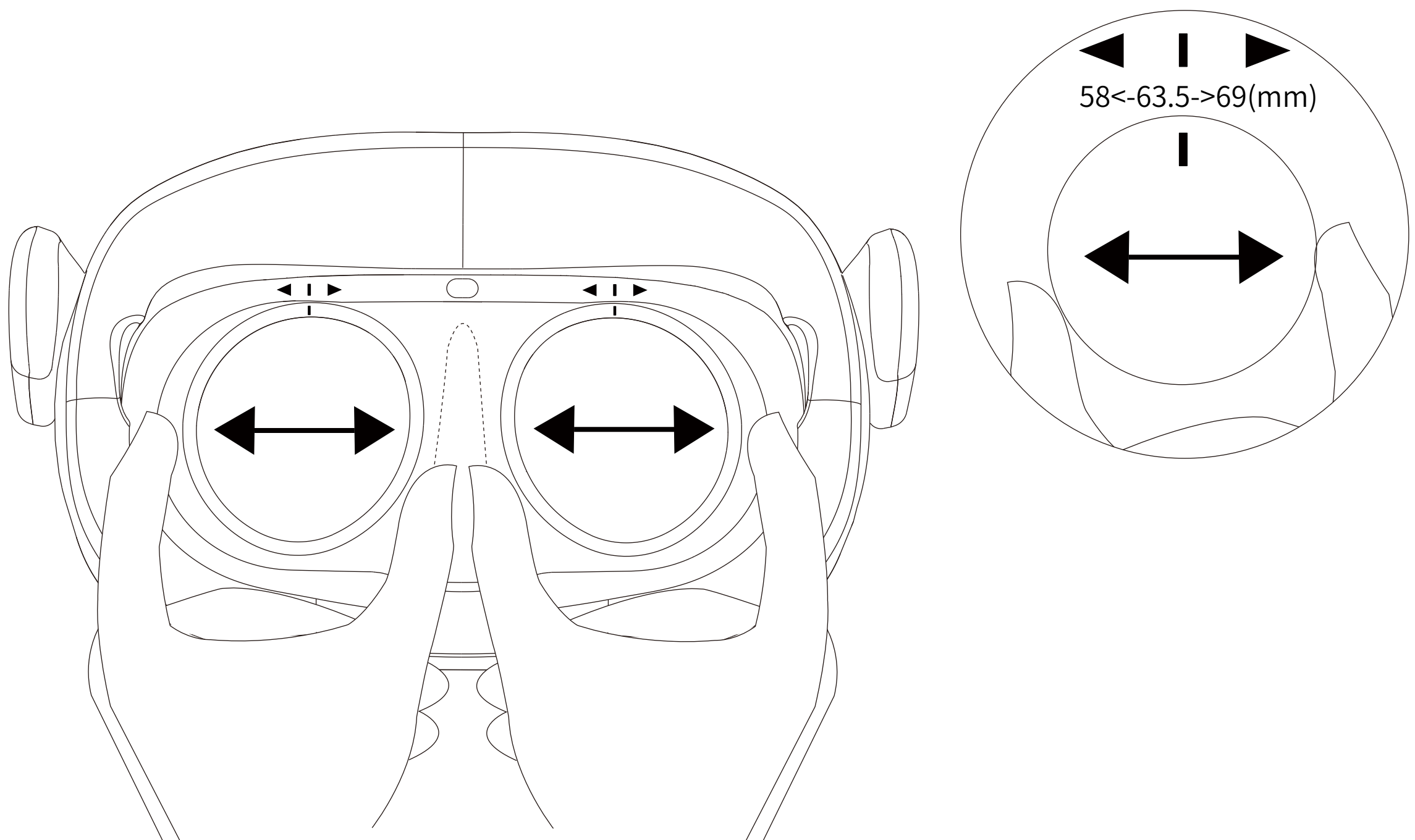

OPERATING INSTRUCTIONS

The VR Headset adjustment

This device has no myopia adjustment function. The VR Headset allows wearing most standard glasses with a frame width of less than 160mm.



OPERATING INSTRUCTIONS

Install Glasses Spacer

If you have glasses collision with headset lens or pressure on the bridge of nose, please follow the picture to install Glasses Spacer to increase the space. You can install or not according to your situation.

1. Disassemble the Face Cushion.
2. Install the Glasses Spacer on the Face Cushion by following the picture.

3. Install the Face Cushion on the Headset.

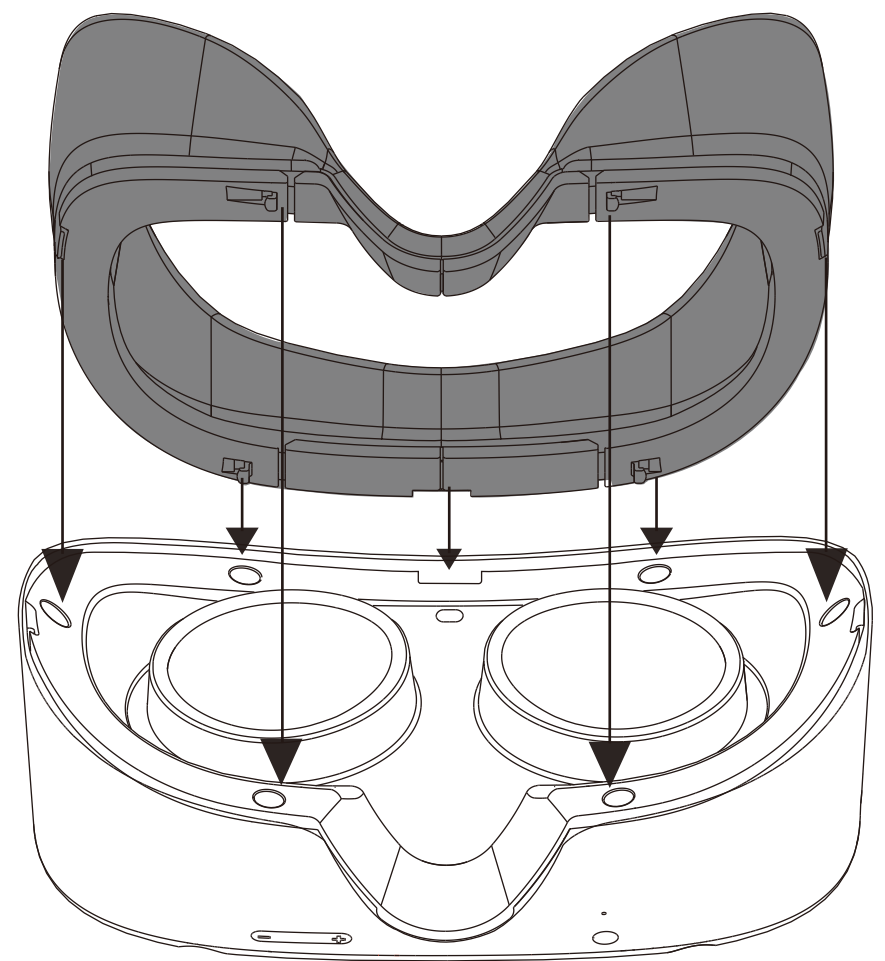
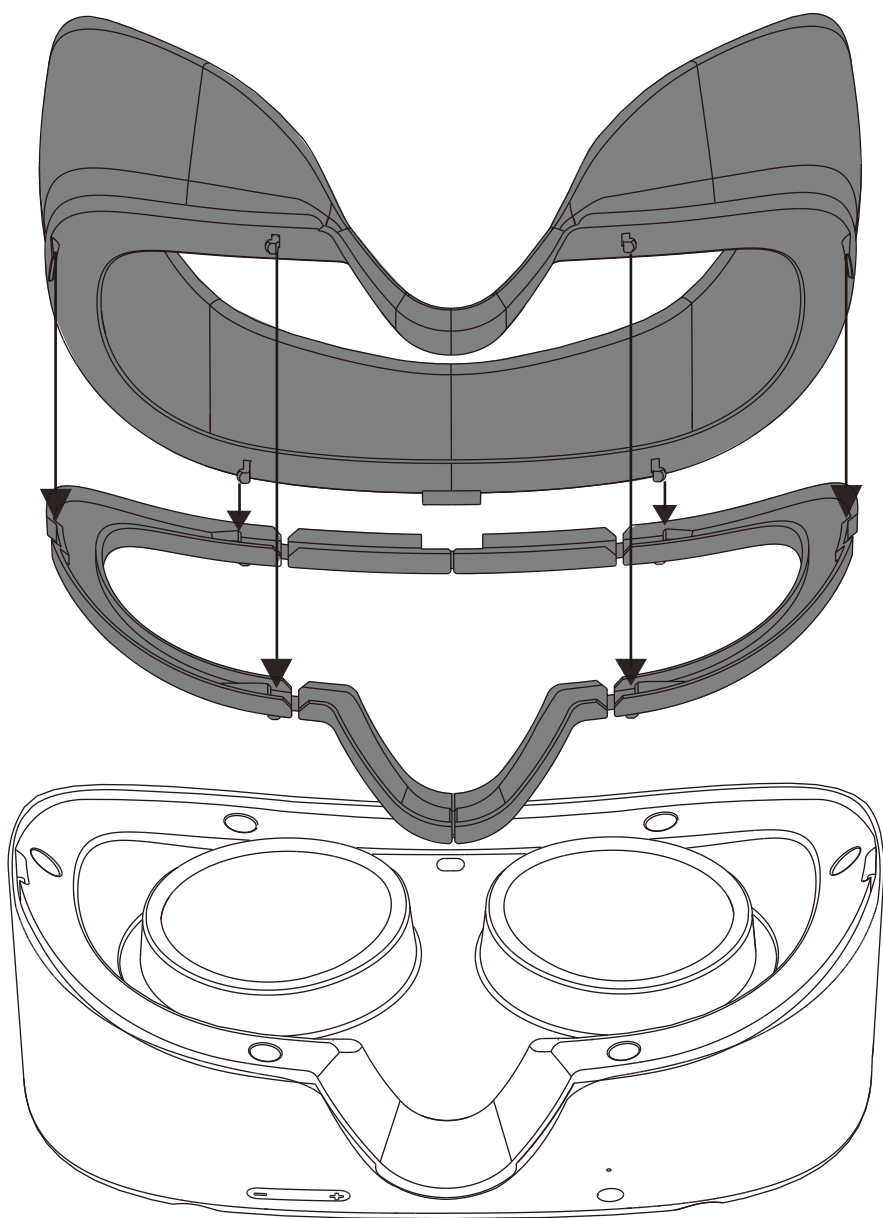

OPERATING INSTRUCTIONS

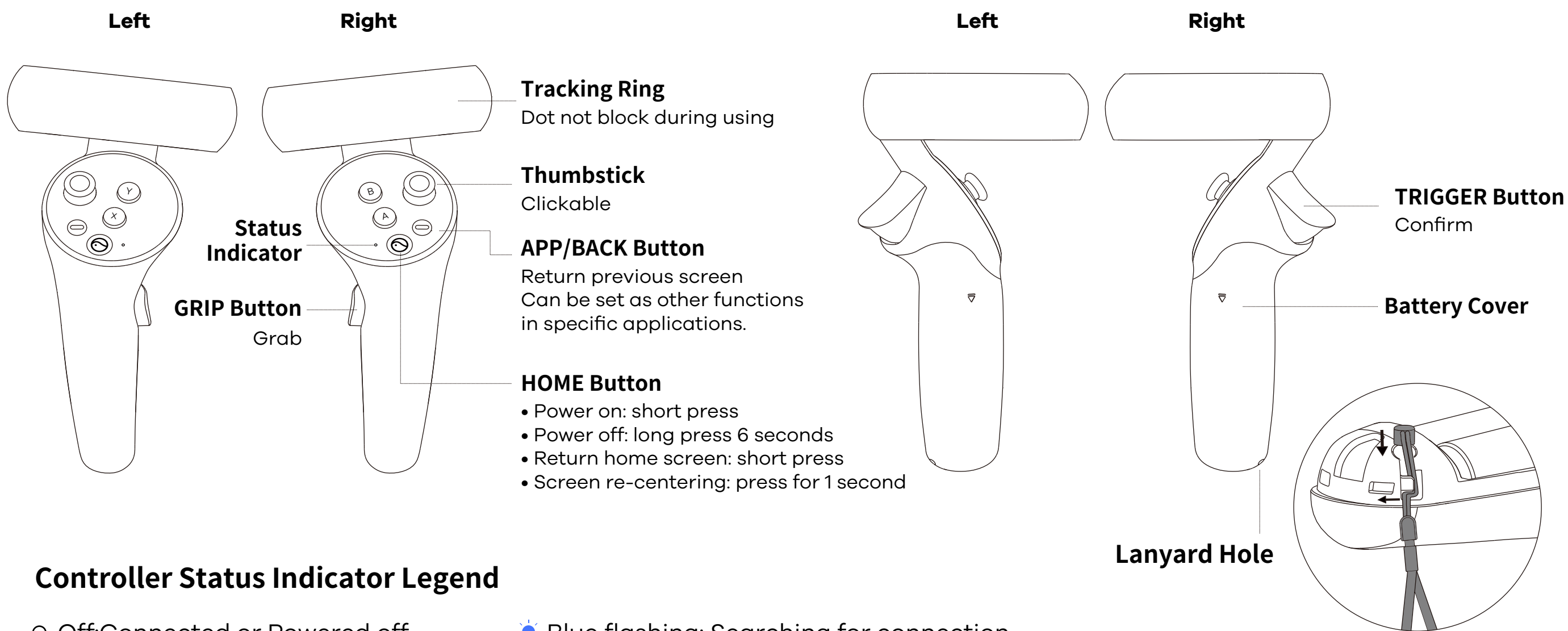

Controller Status Indicator Legend

- Off: Connected or Powered off
- Blue flashing: Searching for connection
- Blue: Firmware updating in progress
- Red and blue flashing alternately: Pairing in progress

***Note: Install the Controller Lanyard by following the above picture.**

Browsing contents

Moving and rotating the Controller/VR Headset to navigation, and select the content with the TRIGGER button of the Controller or the CONFIRM button of the VR Headset.

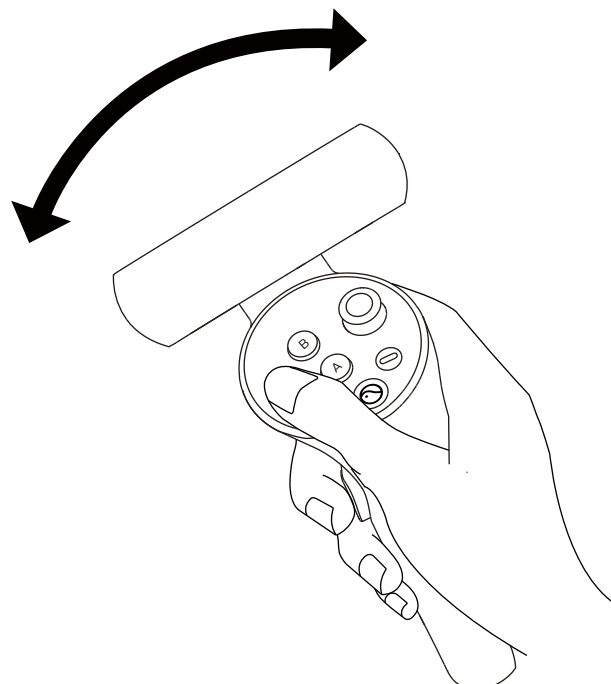

Thumbstick operation

Four directions are available for page-turning; Pressing down is available.

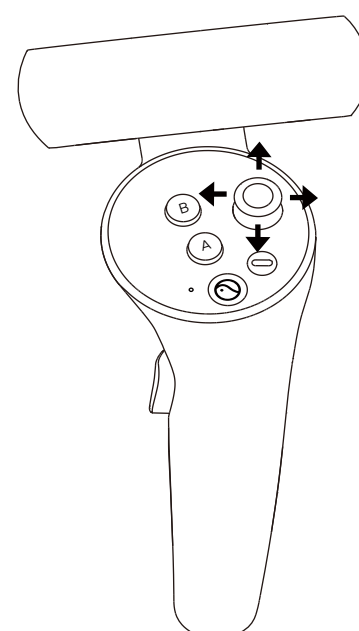

*** Note: You can operate by turning your head and clicking the buttons on the VR Headset if the Controller is not connected.**

OPERATING INSTRUCTIONS

Switch the pointer of the master Controller

In the home screen, short press the TRIGGER button of the corresponding Controller to switch the pointer of the master Controller.

Screen Re-centering

Wear the VR Headset and look straight ahead, press and hold the HOME button of the Controller for more than 1 second to re-center the screen.

Disconnect the Controller

Press and hold the HOME button until the status indicator turns red and the Controller vibrates. The Controller will power off and pairing will reset automatically.

Controllers will automatically shut down to save power in the following cases:

- When the VR Headset enters deep sleep (a while after the VR Headset is taken off)
- When the Controller is unbound in the Controller Management Interface of the VR Headset
- When the VR Headset is powered off

Add new Controller

If you need to add a new Controller (the VR Headset can only connect one left Controller and one right Controller) or re-connect with an unbundled Controller. Go to "Settings" → "Controller", click on "add Controller". Press and hold the HOME button and the TRIGGER button of the Controller at the same time until the red and blue lights of the Controller flashing alternately, and then follow the instructions on the VR Headset screen.

Hardware reset

If the virtual Controller in the VR Headset is stuck, or the HOME button and all buttons of the Controller do not respond, you can remove and reinstall the batteries to restart the Controller.

PRODUCT CARE

This VR headset features replaceable face cushion and straps. The face cushion and straps are available to purchase separately. Please contact customer service at service@picovr.com, or a Pico authorized service provider or your Sales Representative.

Lens care

- During use or storage, please pay attention to avoid hard objects touching the lens to avoid lens scratches.
- Use an optical lens micro-fiber cloth to dip in a little water or use a non-alcoholic disinfectant wipes to clean the lenses. (Do not wipe the lenses with alcohol or other harsh or abrasive cleaning solutions as this may lead to damage.)

Face cushion care

Use a sterile wipes (alcohol-based ingredients allowed) or a microfiber dry cloth dipped in a small amount of 75% alcohol to gently wipe the surface and surrounding areas in contact with the skin until the surface is slightly wet and hold for at least five minutes. Then leave to dry before use (Do not expose directly in sunlight).

Note : The face cushion will have the following phenomena after repeated cleaning and disinfection. Moreover , hand washing or machine washing is not recommended , as this will accelerate the occurrence of the following phenomena. Please change a new face cushion if any of the following occur:

- Leather (PU) face cushion : color change , sticky surface hair, decreased facial comfort of face;
- Fabric face cushion: color change, surface fluff, soft texture, and increased chance for eyewear to come in contact with the lenses.

Headset (except the lens, face cushion), controller and accessories care

Please use disinfectant wipes (alcohol-based ingredients allowed) or use a microfiber dry cloth to dip in a small amount of 75% alcohol and gently wipe the surface of the product until the surface is wet and wait at least 5 minutes, then dry the surface with a microfiber dry cloth.

* Please avoid water into the product when cleaning.

Replacing face cushion

Please follow the picture and pin face cushion into the crevices along the edges.

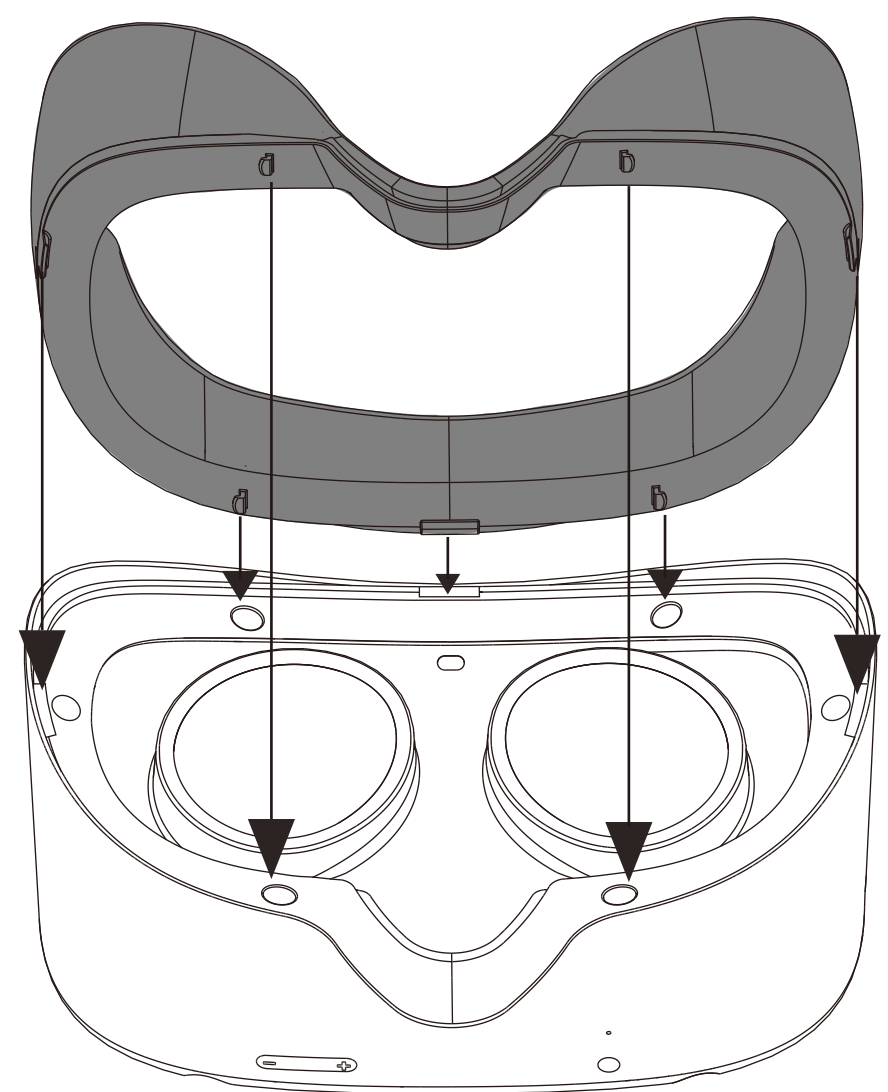
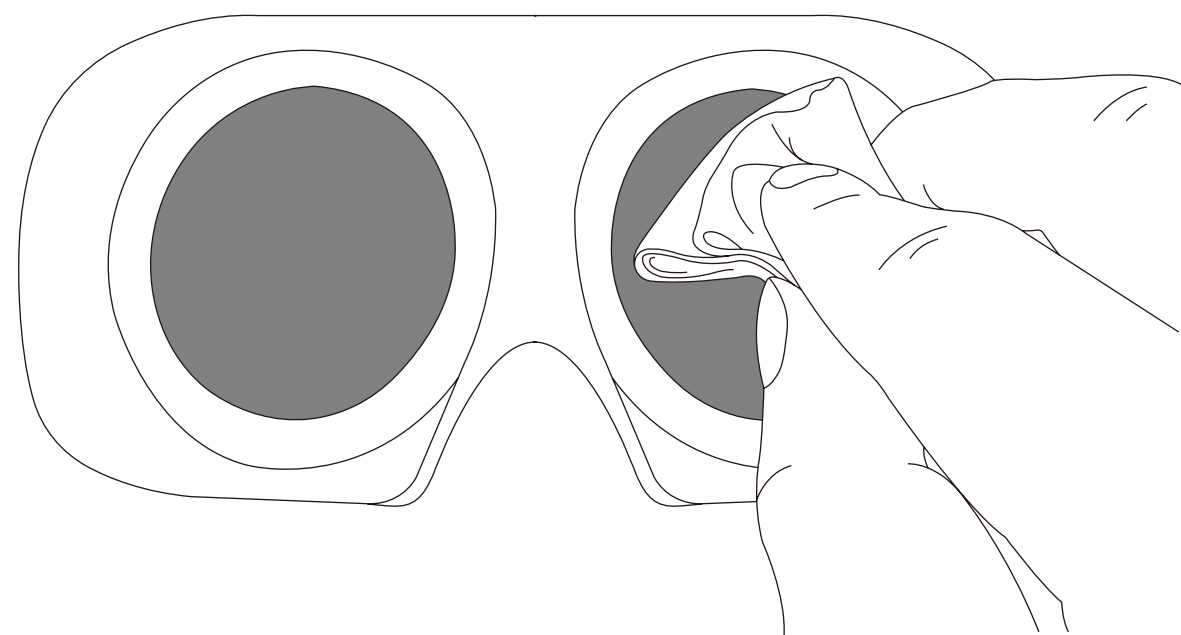

Regulatory:

After powering on the headset, you can go to "Settings" → "General" → "About" → "Regulatory" in the home page to view the certified supervision information of the product in your regional area.

SAFETY WARNING

Please read the following warnings and information carefully before using the VR Headset and follow all guidelines on safety and operation. Failure to follow these guidelines may result in physical injuries (including electric shock, fire and other injuries), property damage and even death.

Health and safety warnings

- Ensure that this product is used in a safe environment. By using this product to view an immersive virtual reality environment, users will not be able to see the physical environment. Move only within the safe area that you set, and keep your surroundings in mind. Do not use near stairs, windows, heat sources or other hazardous areas.
- Confirm that you are in good health before using. Consult a doctor before using if you are pregnant, elderly, or have serious physical, mental, visual, or heart problems.
- A small number of people may experience epilepsy, fainting, severe dizziness, and other symptoms caused by flashes and images, even if they have no such medical history. Consult a doctor before using it if you have a similar medical history or have ever experienced the symptoms listed above.
- Some people may experience severe dizziness, vomiting, palpitations and even fainting when using VR Headsets, playing ordinary video games, and watching 3D movies. Consult a doctor if you have experienced any of the symptoms listed above.
- This product is not recommended for use by children under 12 years of age. Please keep your VR Headset, Controllers, and accessories out of their reach. Children over 12 years old should use this product under adult supervision to avoid accidents.
- Some people may be allergic to plastic, PU, fabric, and other materials used in this product. Long-term contact with skin may result in symptoms such as redness, swelling and inflammation. Stop using the product and consult a doctor if you experience any of the symptoms listed above.
- This product is not meant for extended use over 30 minutes at a time with rest periods of at least 10 minutes between uses. Adjust resting and usage periods if you experience any discomfort.

If you allow others to use this product, you shall be responsible for ensuring that every user knows and follows all safety and operation instructions.

- If you have a big difference in binocular vision, or a high degree of myopia, or astigmatism or far-sightedness, it is suggested that you wear glasses to correct your eyesight when using VR headset.
- Stop using the product immediately if you experience visual abnormalities (diplopia and sight distortion, eye discomfort or pain, etc.), excessive sweating, nausea, vertigo, palpitations, disorientation, loss of balance, etc.
- This product provides access to immersive virtual reality experiences and some types of content may cause discomfort. Stop use immediately and seek medical treatment if the following symptoms occur.
 - Epilepsy seizures, loss of consciousness, convulsions, involuntary movements, dizziness, disorientation, nausea, somnolence, or fatigue.
 - Eye pain or discomfort, eye fatigue, eye twitching, or visual abnormalities (such as illusion, blurred vision, or diplopia).
 - Itchy skin, eczema, swelling, irritation or other discomforts.
 - Excessive sweating, loss of balance, impaired hand-eye coordination, or other similar motion sickness symptoms.

Do not operate a motor vehicle, operate machinery, or engage in activities that may have potentially serious consequences until you have fully recovered from these symptoms.

Impact on medical devices

- Please comply with the expressly stated prohibition of the use of wireless equipment in medical and healthcare facilities, and shut down the equipment and its accessories.

SAFETY WARNING

- Radio waves generated by this product and its accessories may affect the normal operation of implantable medical devices or personal medical devices, such as pacemakers, cochlear implants, hearing aids, etc.

Please consult the medical device manufacturer about the restrictions on the use of this product if you use these medical devices.

- Keep a distance of at least 15cm from the implanted medical devices (such as pacemakers, cochlear implants, etc.) When this product and any accessories are connected. Stop using the headset and/or its accessories if you observe a persistent interference with your medical device.

Operating environment

- Do not use the equipment in dusty, humid, dirty or near strong magnetic fields, so as not to cause internal circuit failure of this product.
- Do not use this equipment during thunderstorms. Thunderstorms may cause product failure and increases the risk of electric shock.
- Operating Temperature: 0-35°C/32-104°F, minimum humidity 5%, maximum humidity 95% RH (non-condensing). Non-Operation (Storage): -20-45°C/ -4-113°F, 85% RH.
- Protect your lenses from light. Keep the product away from direct sunlight or ultraviolet rays, such as windowsills and automobile dashboards or other strong light sources.
- Keep the product and its accessories away from rain or moisture.
- Do not place the product near heat sources or exposed flames, such as electric heaters, microwave ovens, water heaters, stoves, candles or other places that may generate high temperatures.
- Do not apply excessive pressure to the product during storage or when in use to avoid damage to the equipment and lenses.
- Do not use strong chemicals , cleaning agents or detergents to clean the product or its accessories , which may cause material changes that affect eye and skin health. Please follow the instructions in " product care " to take care of the equipment allow children or pets to bite or swallow the product or its accessories.

Children's health

- **CHOKING HAZARD** : This product and its accessories may contain small parts. Please place these out of the reach of children . Children may inadvertently damage the product and its accessories , or swallow small parts resulting in Suffocation or other Injury.

Requirements for accessories

- Only accessories approved by the product manufacturer, such as power supplies and data cables, can be used with the product.
- The use of unapproved third-party accessories may cause fire, explosion or other damages.
- The use of unapproved third-party accessories may violate the warranty terms of the product and the relevant regulations of the country where the product is located. For approved accessories, please contact Pico Customer Service Center.

Environmental protection

- Dispose of your headset and/or accessories properly. Do not dispose of the headset or accessories in a fire or incinerator, as the battery may explode when overheated. Dispose of separately from household waste.
- Please comply with the local laws and regulations on the disposal of electrical and electronic equipment to dispose of this product and its accessories.

Hearing protection

- Do not use high volume for extended periods of time to prevent possible hearing damage.
- When using headphones, use the minimum volume required to hear the audio so as not to damage your hearing. Prolonged exposure to high volume may cause permanent hearing damage.

Flammable and explosive areas

- Do not use the equipment near fuel stations, near any hazardous areas containing flammable articles and chemical agents. Follow all graphic or text instructions when in possession of the product around these areas. Operating the product in these hazardous sites may cause explosions or fires.
- Do not store or transport the product or its accessories in the same container as flammable liquids, gases, or substances.

SAFETY WARNING

Transportation safety

- Do not use the product when walking, cycling, driving, or other situations that require full visibility.
- Take caution if using the product as a passenger in a motor vehicle, as irregular movement may increase the risk of motion sickness.

Charger safety

- Only charging devices provided in the product package or specified as an approved device by the manufacturer should be used.
- When charging is completed, disconnect the charger from the equipment and unplug the charger from the power outlet.
- If the charging adapter or cable is damaged, discontinue using to prevent the risk of electric shock or fire.
- Do not operate the equipment or charger with wet hands to avoid short circuits, failure or electric shock.
- Do not use the charger if wet.

Battery safety

- VR Headsets are equipped with non-removable internal batteries. Do not attempt to replace the battery, as doing so may cause battery damage, fire or human injury. The battery can only be replaced by Pico or Pico authorized service providers.
- Do not disassemble or modify the battery, insert foreign objects, or immerse in water or other liquid. Handling the battery as such can cause chemical leakage, overheating, fire, or explosion. If the battery appears to be leaking material, avoid any contact with skin or eyes.
- In case of material contact with skin or eyes, immediately rinse with clear water and contact your local poison authority.
- Do not drop, squeeze or puncture the battery. Avoid subjecting the battery to high temperatures or external pressure, which may result in corruption and overheating of the battery.

PRODUCT WARRANTY TERMS

Devices can be repaired, free of charge, within 12 months of the purchase date. Please contact Pico's support if you require repair services.

Limited warranty

The limited warranty does not cover:

- Defects or damage resulting from improper usage, maintenance or storage not included in this manual;
- Storing or shipping items not included with the original product inside the original product packaging;
- Defects or damage resulting from unauthorized disassembly, alteration, or maintenance;
- Damage caused by force majeure such as fire, flood and lightning, etc.
- The product has exceeded the valid period of the warranty.

LAWS AND REGULATIONS

Copyright © 2015-2022 Qingdao Pico Technology Co., Ltd. All Rights Reserved

This information is for reference only and does not constitute any form of commitment. Products (including but not limited to color, size, screen display, etc.) shall be subject to physical objects.

User Software License Agreement

Before using the product, please read the software license agreement carefully. When starting to use the product, you agree to be bound by the license agreement.

If you do not agree to the terms of this agreement, do not use the product and software, and return the product to its original place for refund.

For more details about the agreement, please visit:

https://www.pico-interactive.com/terms/user_terms.html

Privacy Protection

To learn how we protect your personal information, please visit:

<https://www.pico-interactive.com/terms/privacy.html>

Read our privacy policy.

Product Name: VR All-In-One Headset

Headset Model: A7H10

Controller Model: C1710

For more information about Pico's products, policy, and authorized servers, please visit

Pico's official website: www.pico-interactive.com

Company Name: Qingdao Pico Technology Co., Ltd

Company Address: 4th Floor, No.3 Building, No.393 Songling Road, Qingdao, Shandong, P.R. China

Tel: +86 400-6087-666

Service Mail: service@picovr.com